

Classic Fireside Collection



*by
Classic Cast Stone
of Dallas*

Welcome to the Classic Fireside Collection By Classic Cast Stone of Dallas

About Us

Classic Cast Stone of Dallas has been designing and manufacturing cast stone mantels since 1987 and has amassed a collection of original designs provided for some of the most prestigious homes across the country. All work is performed at our 35,000 square foot facility in Garland, Texas.

How to Order

Please call us to place your order. Because we size each mantel to fit, we will need dimensions of your existing firebox and surrounding area. Our design staff will gladly help with any questions. For ordering call (972) 276-2000.

Color Samples

We offer 3 standard colors (see page 12). Color samples available upon request.

Our Product

We craft our mantels with the highest quality fine grade aggregates along with a perfect blend of admixtures and hardeners to achieve the highest quality cast stone product on the market.

Our Payment terms

We require a 50% deposit prior to production. The balance is due prior to shipping. Any changes made after an order has been placed may be subject to additional charges. Deposits are non-refundable after production has begun. At this time we only accept payment by check. **Please make checks payable to: Classic Cast Stone of Dallas.**

Production time

Most orders are ready for shipment within 4 weeks. Customization and larger mantel orders can add to production time. If a rush order is necessary we will make every effort to accommodate your time frame.

Inquire about our stock inventory for immediate delivery.

Delivery

Our mantels are packaged on pallets and shipped via common carrier or flat bed 18 semi truck depending on the type of mantel and destination. You will be required to offload the material from the truck. Due to weight of the material we recommend having a forklift for offloading. Some mantels can be uncrated and offloaded by hand but most of our mantels include pieces weighing over 200lbs. In cases where delivery directly to the jobsite is difficult, the customer may elect to arrange for a secondary delivery location such as a brickyard or warehouse.

Installation

We recommend an experienced stone mason for installation. We will provide setting drawings showing dimensions, part numbers, and section details. We do not provide any loose hardware, fasteners, adhesives, shims, or grout. For technical assistance call 972-276-2000.

Atlas



60" Atlas
(shown with custom overmantel)

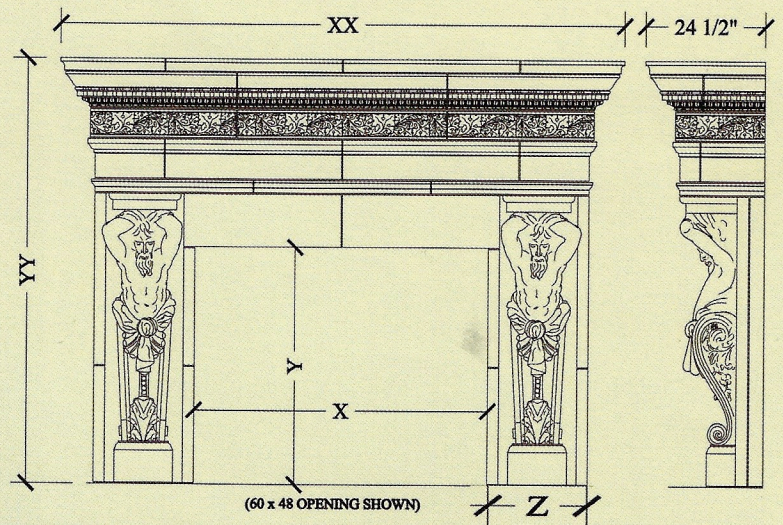

MODEL#	X	Y	Z	XX	YY
M1500-40	60	48	20 1/2	115 1/2	86

The opening size is adjustable and may be modified to fit your firebox.

Optional overmantels are available (page 13)

Please contact our design department for assistance. (972) 276-2000

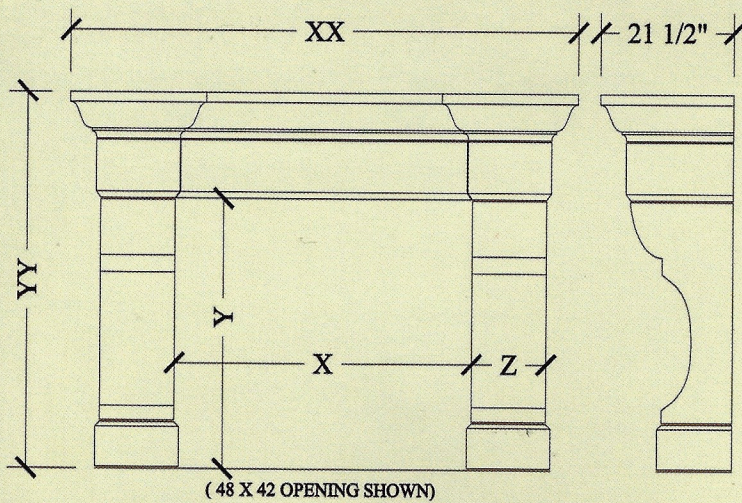

MODEL#	X	Y	Z	XX	YY
* M125-36	36	34	12	76	55 1/2
M125-42	42	34	12	76	55 1/2
M125-48	48	42	12	82	58 1/4
M125-54	54	47 3/4	12	88	64

The opening size is adjustable and may be modified to fit your firebox.

Optional overmantels are available (page 13)

Please contact our design department for assistance. (972) 276-2000

Augusta



48" Augusta

Belview



48" Belview

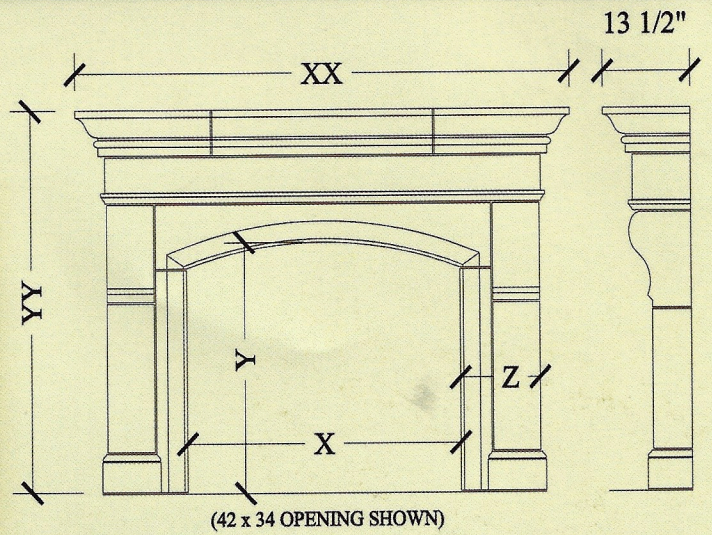

MODEL#	X	Y	Z	XX	YY
M1800-36	36	36	11 1/2	68 1/2	52 3/4
M1800-42	42	36	12 1/4	76	52 3/4
M1800-48	48	38	12	81 1/2	56

The opening size is adjustable and may be modified to fit your firebox.

Optional overmantels are available (page 13)

Please contact our design department for assistance. (972) 276-2000

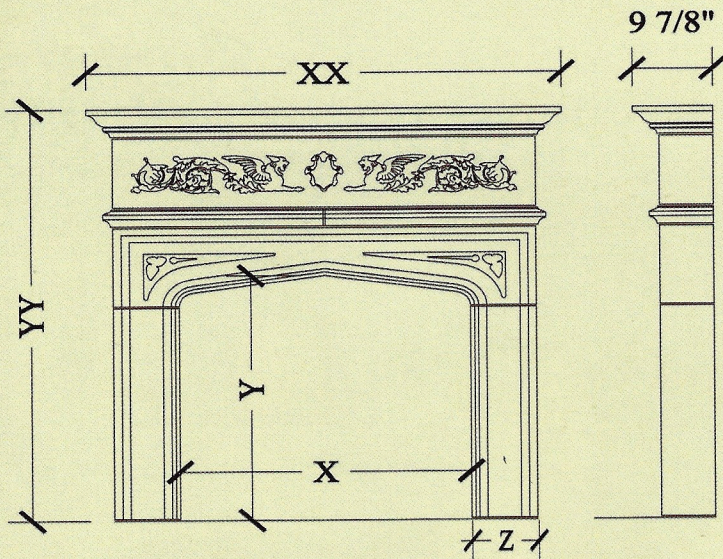

MODEL#	X	Y	Z	XX	YY
M1800-36	36	36	8 1/8	58 1/2	60 1/2

The opening size is adjustable and may be modified to fit your firebox.

Optional overmantels are available (page 13)

Please contact our design department for assistance. (972) 276-2000

Beverly



36" Beverly
(shown with optional side pieces)

Chateau



48" Chateau

(shown with optional overmantel)

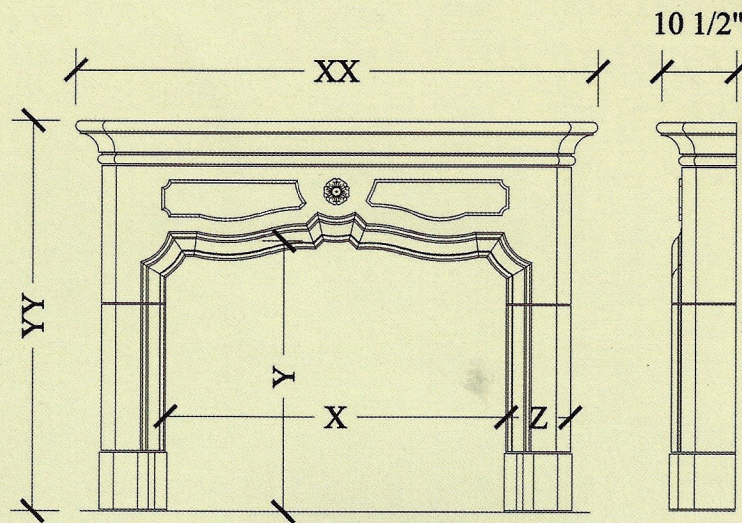

48 x 38 OPENING SHOWN

MODEL#	X	Y	XX	YY	Z
M500-48	47 3/4	38	73 1/4	54 1/2	9
M500-64	64	42	89 1/2	58 3/4	9

The opening size is adjustable and may be modified to fit your firebox.

Optional overmantels are available (page 13)

Please contact our design department for assistance. (972) 276-2000

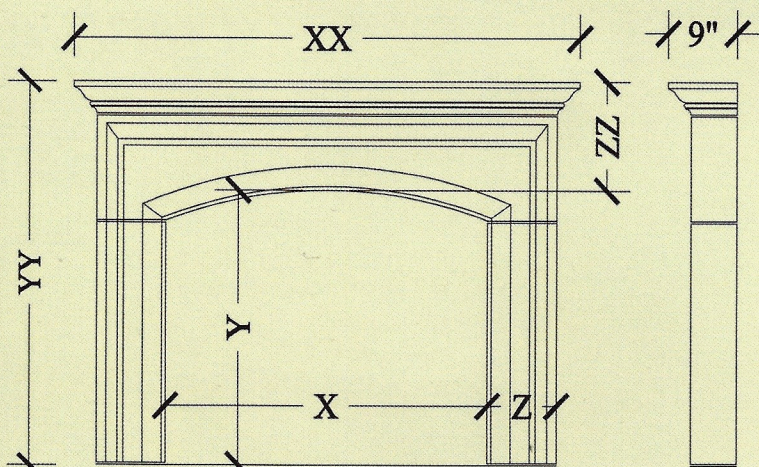

(42 x 34 OPENING SHOWN)

MODEL#	X	Y	Z	XX	YY
M175-36	36	30	9	60	43
M175-42	42	34	9	66	47 1/4
M175-48	48	38	9	72 1/2	51 1/2
M175-60	60	45 1/2	9	84 1/2	58 5/16

The opening size is adjustable and may be modified to fit your firebox.

Optional overmantels are available (page 13)

Please contact our design department for assistance. (972) 276-2000

Classic Cast Stone of Dallas (972) 276-2000 www.classiccaststone.com

Durham



48" Durham
(shown with optional filler panels)

Fairview



42" Fairview

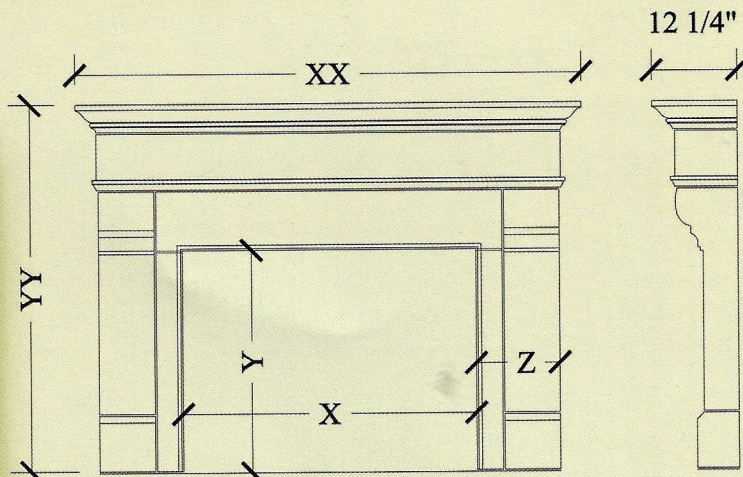

(42 x 34 OPENING SHOWN)

MODEL#	X	Y	Z	XX	YY
M1400-36	36	32	12	66 1/2	52 3/4
M1400-40	40	34	12	70 1/2	54 3/4
M1400-42	42	36	12	72 1/2	56 3/4
M1400-48	48	38	12	78 1/2	58 3/4
M1400-50	50 1/2	40	12	81 1/2	60 3/4

The opening size is adjustable and may be modified to fit your firebox.

Optional overmantels are available (page 13)

Please contact our design department for assistance. (972) 276-2000

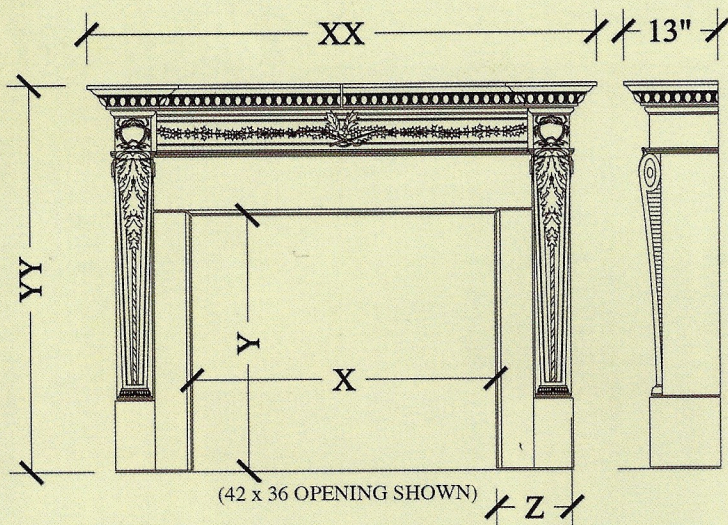

(42 x 36 OPENING SHOWN)

MODEL#	X	Y	Z	XX	YY
M1000-36	36	36	13 3/8	70 3/4	54 3/4
M1000-42	42	36	10 3/8	70 3/4	54 3/4
M1000-48	48	38	7 3/8	70 3/4	54 3/4

The opening size is adjustable and may be modified to fit your firebox.

Optional overmantels are available (page 13)

Please contact our design department for assistance. (972) 276-2000

Geneva



48" Geneva

Granada



48" Granada

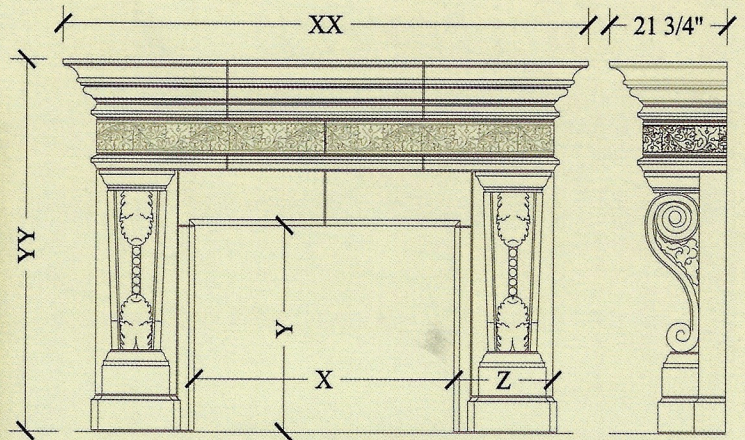

(42 x 38 OPENING SHOWN)

MODEL#	X	Y	Z	XX	YY
M1100-42	42	36	18 1/4	91	64 3/4
M1100-42	48	36	18 1/4	97	64 3/4

The opening size is adjustable and may be modified to fit your firebox.

Optional overmantels are available (page 13)

Please contact our design department for assistance. (972) 276-2000

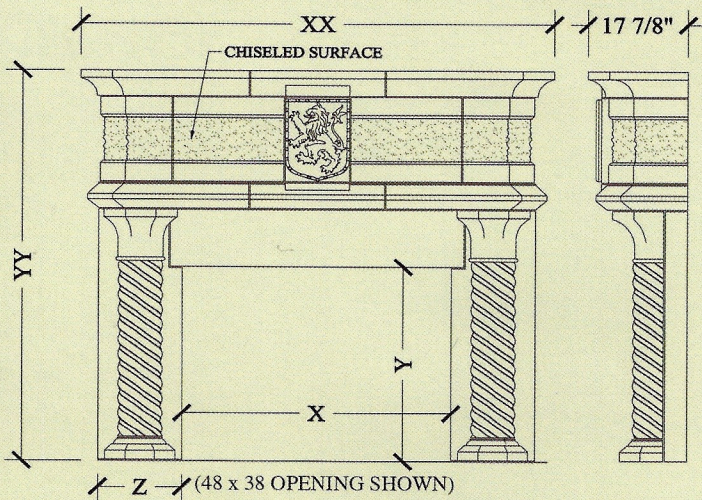

(48 x 38 OPENING SHOWN)

MODEL#	X	Y	Z	XX	YY
M1200-42	42	34	15	79 1/2	76 3/8
M1200-48	48	38	15	85 1/2	76 3/8
M1200-54	54	42	15	91 1/2	76 3/8

The opening size is adjustable and may be modified to fit your firebox.

Optional overmantels are available (page 13)

Please contact our design department for assistance. (972) 276-2000

Hawksmore



48" Hawksmore

Mediterranean



48" Mediterranean

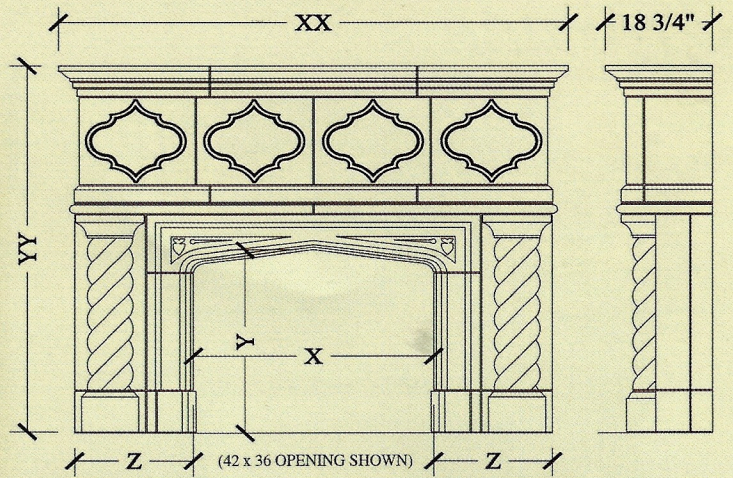

MODEL#	X	Y	Z	XX	YY
M750-36	36	36	20 3/4	82 1/2	71 7/8
M750-42	42	36	20 3/4	89 1/8	71 7/8
M750-48	48	38	20 3/4	95	73 1/2
M750-54	54	43	20 3/4	100 1/2	79 3/8
M750-60	59 5/8	48	25 13/16	116 3/4	83 3/8

The opening size is adjustable and may be modified to fit your firebox.

Optional overmantels are available (page 13)

Please contact our design department for assistance. (972) 276-2000

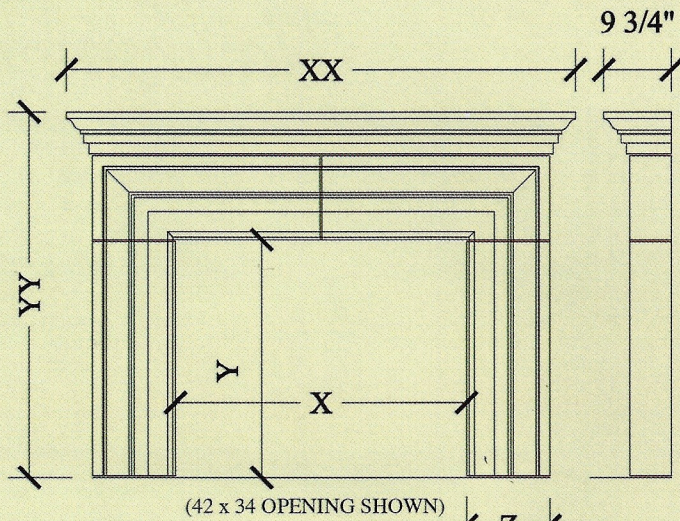

MODEL#	X	Y	Z	XX	YY
M310-36	36	30	12	66 7/8	48 7/16
M310-42	42	34	12	72 7/8	52 7/16
M310-48	48	38	12	78 7/8	56 7/16
M310-54	54	42	12	84 7/8	60 7/16

The opening size is adjustable and may be modified to fit your firebox.

Optional overmantels are available (page 13)

Please contact our design department for assistance. (972) 276-2000

Newgate



48" Newgate

Norfolk



48" Norfolk

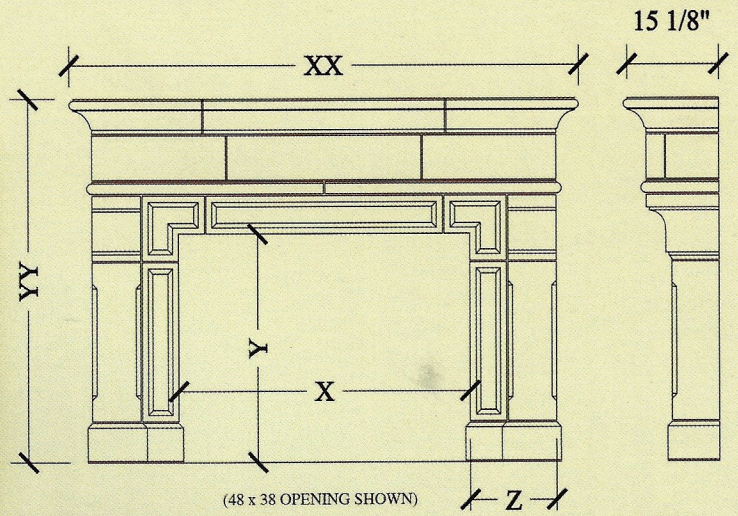

(48 x 38 OPENING SHOWN)

MODEL#	X	Y	Z	XX	YY
M600-36	36	30	14 1/4	72	51 1/4
M600-42	42	34	14 1/4	84	55 1/4
M600-48	48	38	14 1/4	90	59 1/4
M600-54	54	40	14 1/4	108	63 1/4

The opening size is adjustable and may be modified to fit your firebox.

Optional overmantels are available (page 13)

Please contact our design department for assistance. (972) 276-2000

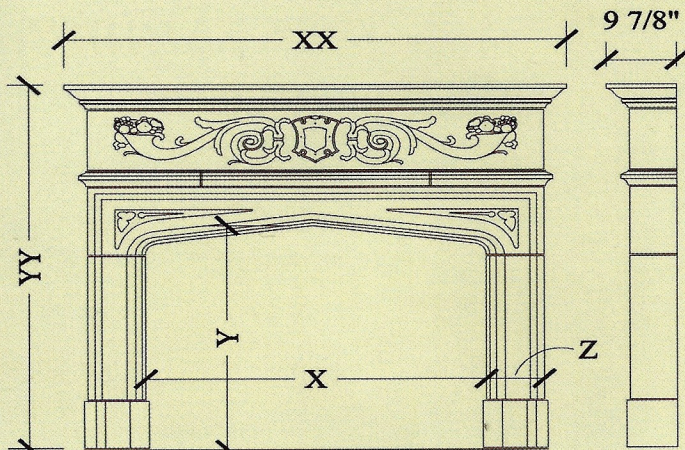

(48 x 38 OPENING SHOWN)

MODEL#	X	Y	Z	XX	YY
M400-42	42	36	8 1/8	64 3/4	60 3/8
M400-48	48	38	8 1/8	70 3/4	62
M400-54	54	43	8 1/8	76 3/4	67 3/8

The opening size is adjustable and may be modified to fit your firebox.

Optional overmantels are available (page 13)

Please contact our design department for assistance. (972) 276-2000

Oxford



42" Oxford

Purdue



36" Purdue

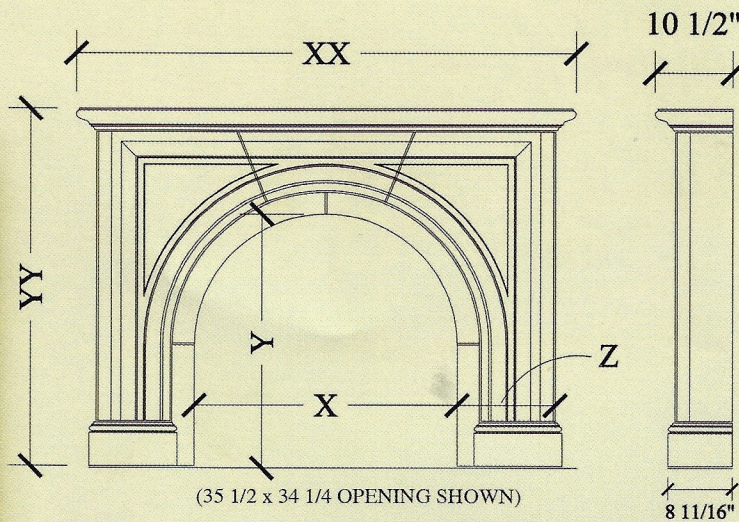

MODEL#	X	Y	Z	XX	YY
M1600-36	35 1/2	* 37 1/4	13 1/4	67 1/2	51 1/2
M1600-42	42	* 40 1/2	10	67 1/2	51 1/2

* MAXIMUM OPENING HEIGHT

The opening size is adjustable and may be modified to fit your firebox.

Optional overmantels are available (page 13)

Please contact our design department for assistance. (972) 276-2000

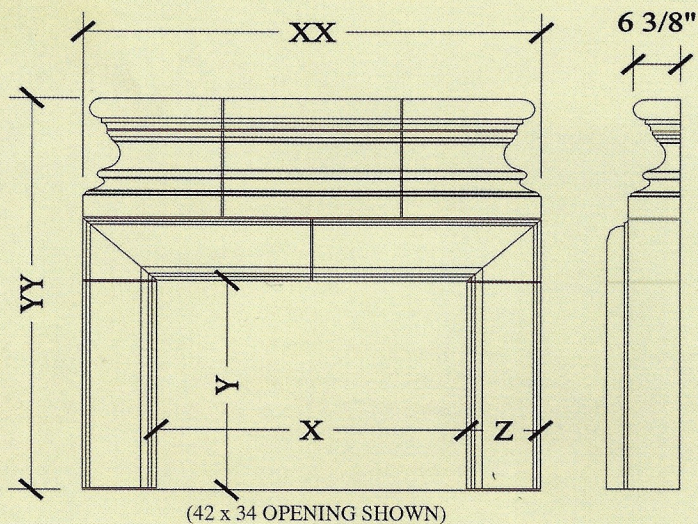

MODEL#	X	Y	Z	XX	YY
M150-36	36	30	10	56	59 1/2
M150-42	42	34	10	62	63 1/2
M150-48	48	38	10	68	67 1/2
M150-54	54	43	10	74	72 1/2

The opening size is adjustable and may be modified to fit your firebox.

Optional overmantels are available (page 13)

Please contact our design department for assistance. (972) 276-2000

Sullivan



36" Sullivan

St. James



36" St. James

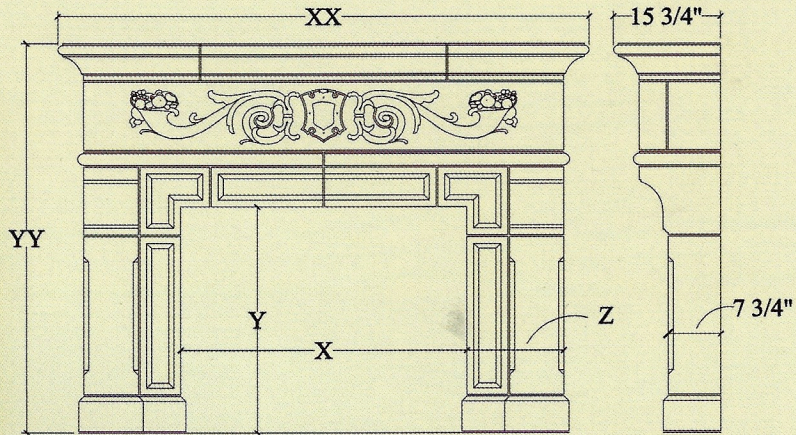

(42 x 34 OPENING SHOWN)

MODEL#	X	Y	Z	XX	YY
M650-36	36	30	14 1/4	72	54 1/2
M650-42	42	34	14 1/4	78	58 1/2
M650-48	48	38	14 1/4	84	62 1/2

The opening size is adjustable and may be modified to fit your firebox.

Optional overmantels are available (page 13)

Please contact our design department for assistance. (972) 276-2000

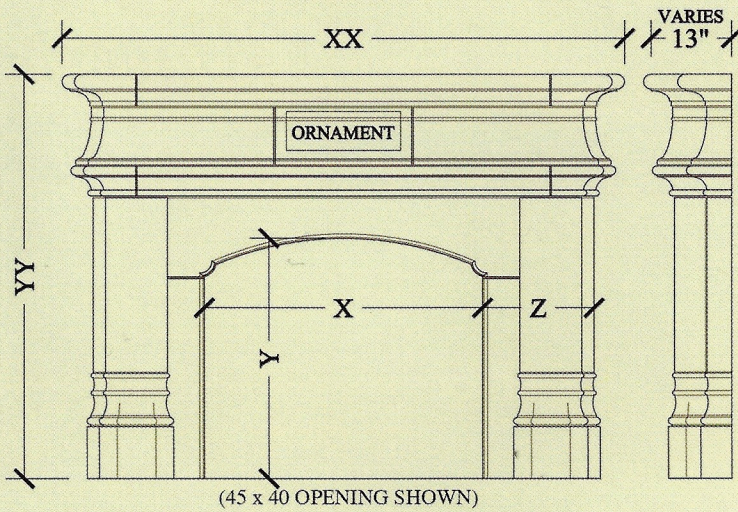

(45 x 40 OPENING SHOWN)

MODEL#	X	Y	Z	XX	YY
M2000-45	45	40	18	91	67 1/4

The opening size is adjustable and may be modified to fit your firebox.

Optional overmantels are available (page 13)

Please contact our design department for assistance. (972) 276-2000

Classic Cast Stone of Dallas (972) 276-2000

Tuscany



45" Tuscany

Vista



48" Vista

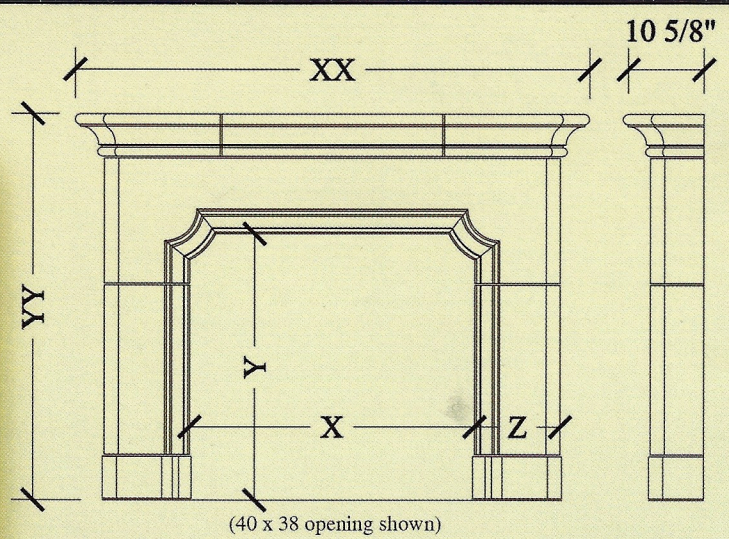

(40 x 38 opening shown)

MODEL#	X	Y	Z	XX	YY
M1300-40	40	38	12	71 1/2	55
M1300-48	48	38	12	79 1/2	55

The opening size is adjustable and may be modified to fit your firebox.

Optional overmantels are available (page 13)

Please contact our design department for assistance. (972) 276-2000

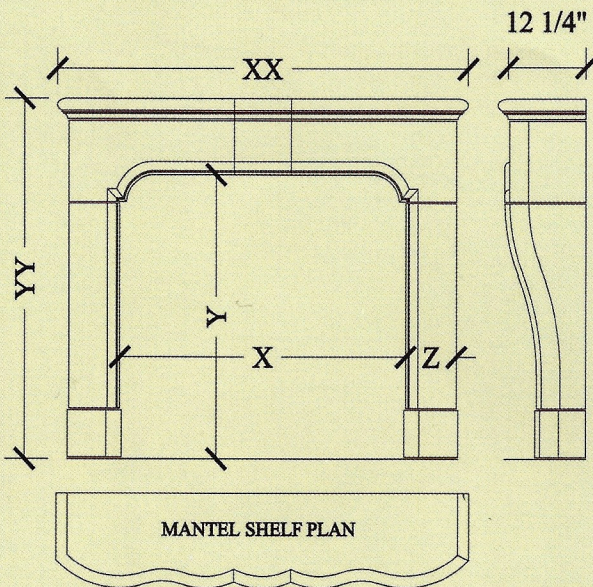

MODEL#	X	Y	Z	XX	YY
M2200-36	45	42	8	64 5/8	53 1/4

The opening size is adjustable and may be modified to fit your firebox.

Optional overmantels are available (page 13)

Please contact our design department for assistance. (972) 276-2000

Waverly



45" Waverly
(shown with optional filler panels)

Williams



48" Williams

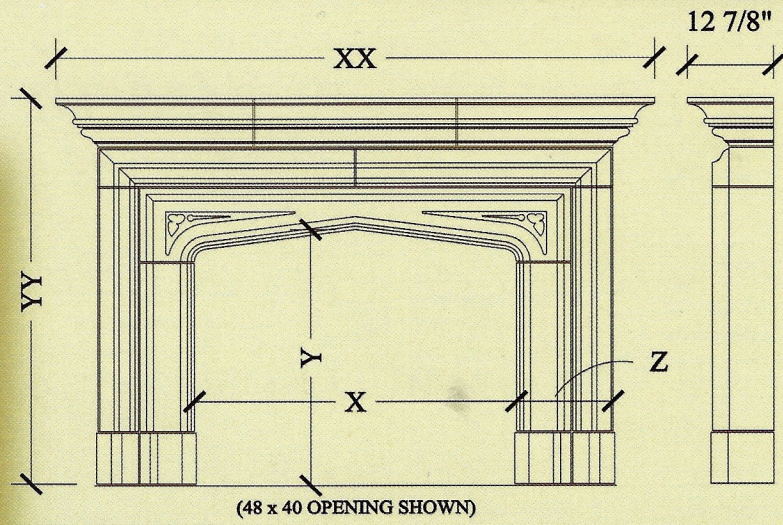

MODEL#	X	Y	Z	XX	YY
M950-36	36	36	14 3/8	77 1/4	57
M950-42	41 1/2	36	14 3/8	83 1/4	56 5/8
M950-48	48	40	14 3/8	89 1/8	60 1/4
M950-54	54	43	14 3/8	95 1/4	64

The opening size is adjustable and may be modified to fit your firebox.

Optional overmantels are available (page 13)

Please contact our design department for assistance. (972) 276-2000

Color Options



Textures

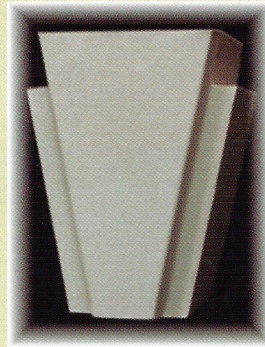

STANDARD
(smooth)



DISTRESSED
(pitted finish)

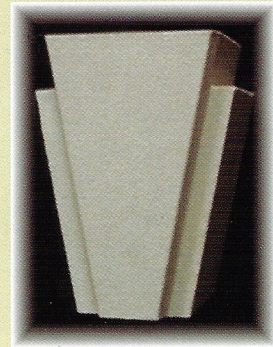

SANDBLAST
(rough finish)

Hearth Options

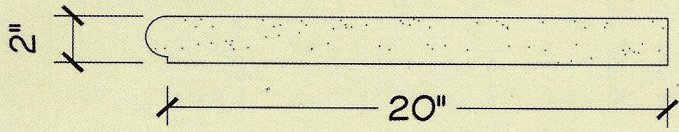

2" BULLNOSE

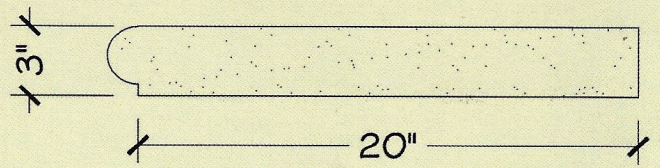

2" BULLNOSE

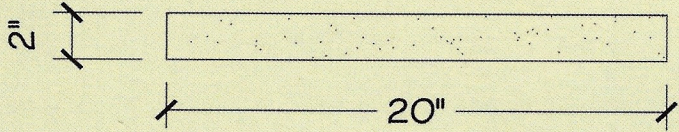

2" SQUARE/FLUSH

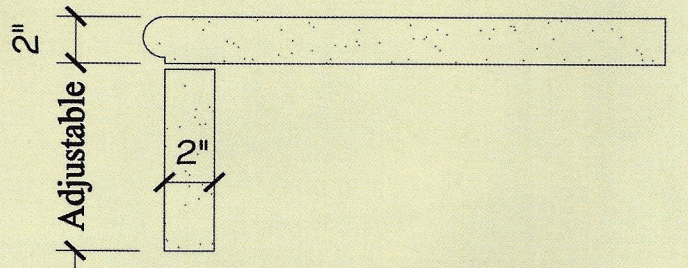

RAISED HEARTH

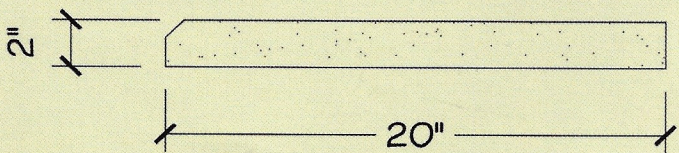

2" BEVELED

Overmantel Options

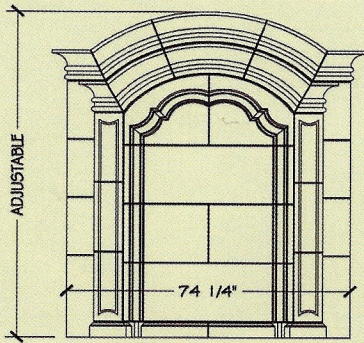

MODEL # - OM100

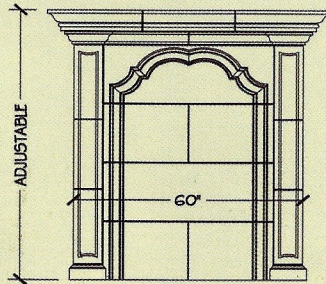

MODEL # - OM200

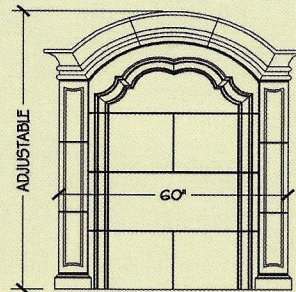

MODEL # - OM300

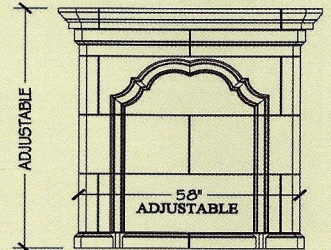

MODEL # - OM400

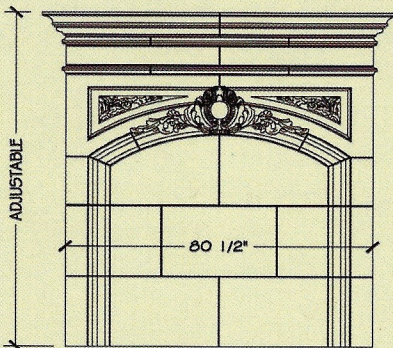

MODEL # - OM500

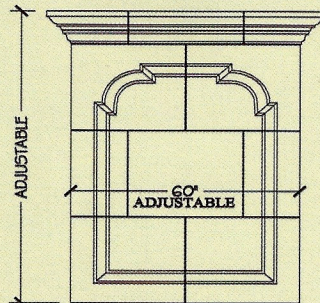

MODEL # - OM600

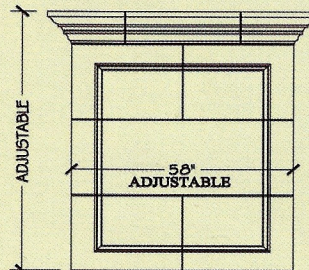

MODEL # - OM700

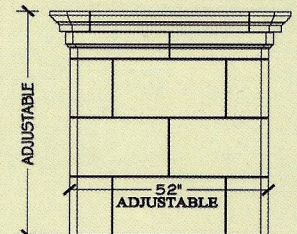

MODEL # - OM800

We invite you to view
our other products



SLATE SELECT

A Superior Alternative to Slate

www.slateselect.com



*Classic Cast Stone of Dallas
architectural cast stone products*

www.classiccaststone.com



Modular cabinets for outdoor living areas



Modular Exterior Cabinet Systems

www.exteriorcabinets.com